

# Instructions for use

## WASHING MACHINE

**GB**

English,1

**FR**

Français,13

**IT**

Italiano,25

**ES**

Español,37

**PT**

Português,49

**WMD 942**

### Contents

#### Installation, 2-3

Unpacking and levelling  
Connecting the electricity and water supplies  
The first wash cycle  
Technical data

#### Description of the washing machine, 4-5

Control panel  
Display

#### Running a wash cycle, 6

#### Wash cycles and functions, 7

Table of wash cycles  
Wash functions

#### Detergents and laundry, 8

Detergent dispenser drawer  
Preparing the laundry  
Special wash cycles  
Load balancing system

#### Precautions and tips, 9

General safety  
Disposal  
Opening the porthole door manually

#### Care and maintenance, 10

Cutting off the water or electricity supply  
Cleaning the washing machine  
Cleaning the detergent dispenser drawer  
Caring for the door and drum of your appliance  
Cleaning the pump  
Checking the water inlet hose

#### Troubleshooting, 11

#### Service, 12

GB

# Installation

GB

! This instruction manual should be kept in a safe place for future reference. If the washing machine is sold, transferred or moved, make sure that the instruction manual remains with the machine so that the new owner is able to familiarise himself/herself with its operation and features.

! Read these instructions carefully: they contain vital information relating to the safe installation and operation of the appliance.

## Unpacking and levelling

### Unpacking

1. Remove the washing machine from its packaging.
2. Make sure that the washing machine has not been damaged during the transportation process. If it has been damaged, contact the retailer and do not proceed any further with the installation process.

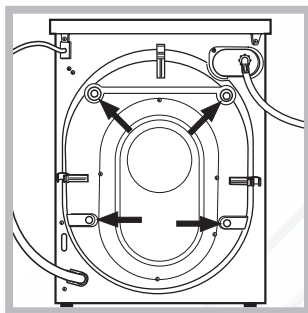

3. Remove the 4 protective screws (used during transportation) and the rubber washer with the corresponding spacer, located on the rear part of the appliance (see figure).

4. Close off the holes using the plastic plugs provided.
5. Keep all the parts in a safe place: you will need them again if the washing machine needs to be moved to another location.

! Packaging materials should not be used as toys for children.

### Levelling

1. Install the washing machine on a flat sturdy floor, without resting it up against walls, furniture cabinets or anything else.

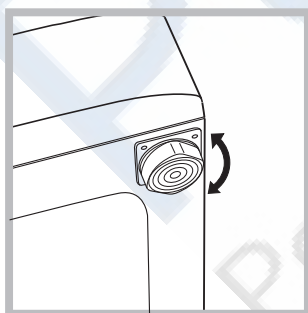

2. If the floor is not perfectly level, compensate for any unevenness by tightening or loosening the adjustable front feet (see figure); the angle of inclination, measured in relation to the worktop, must not exceed 2°.

Levelling the machine correctly will provide it with stability, help to avoid vibrations and excessive noise and prevent it from shifting while it is operating. If it is placed on carpet or a rug, adjust the feet in such a way as to allow a sufficient ventilation space underneath the washing machine.

## Connecting the electricity and water supplies

### Connecting the water inlet hose

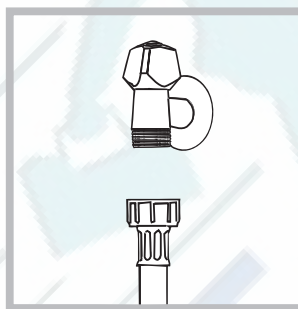

1. Connect the supply pipe by screwing it to a cold water tap using a  $\frac{3}{4}$  gas threaded connection (see figure).

Before performing the connection, allow the water to run freely until it is perfectly clear.

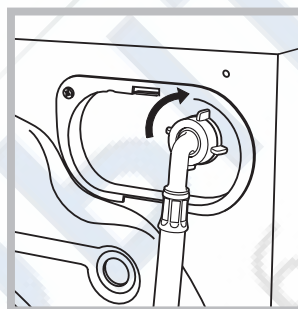

2. Connect the inlet hose to the washing machine by screwing it onto the corresponding water inlet of the appliance, which is situated on the top right-hand side of the rear part of the appliance (see figure).

3. Make sure that the hose is not folded over or bent.

! The water pressure at the tap must fall within the values indicated in the Technical details table (see page 3).

! If the inlet hose is not long enough, contact a specialised shop or an authorised technician.

! Never use second-hand hoses.

! Use the ones supplied with the machine.

### Connecting the drain hose

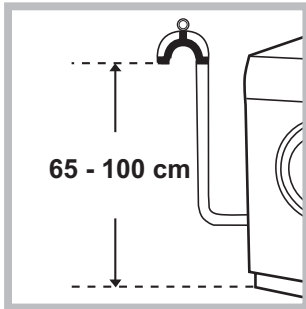

Connect the drain hose, without bending it, to a drainage duct or a wall drain located at a height between 65 and 100 cm from the floor;

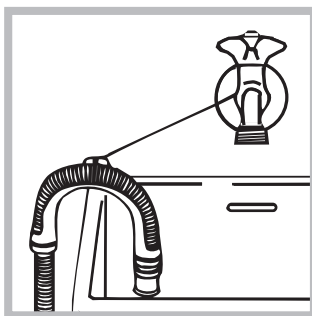

alternatively, rest it on the side of a washbasin or bathtub, fastening the duct supplied to the tap (see figure). The free end of the hose should not be underwater.

! We advise against the use of hose extensions; if it is absolutely necessary, the extension must have the same diameter as the original hose and must not exceed 150 cm in length.

### Electrical connections

Before plugging the appliance into the electricity socket, make sure that:

- the socket is earthed and complies with all applicable laws;
- the socket is able to withstand the maximum power load of the appliance as indicated on the Technical Data Plate fixed on the machine;
- the power supply voltage falls within the values indicated on the Technical Data Plate fixed on the machine;
- the socket is compatible with the plug of the washing machine. If this is not the case, replace the socket or the plug.

! The washing machine must not be installed outdoors, even in covered areas. It is extremely dangerous to leave the appliance exposed to rain, storms and other weather conditions.

! When the washing machine has been installed, the electricity socket must be within easy reach.

! Do not use extension cords or multiple sockets.

! The cable should not be bent or compressed.



! The power supply cable must only be replaced by authorised technicians.

Warning! The company shall not be held responsible in the event that these regulations are not respected.

### The first wash cycle

Once the appliance has been installed, and before you use it for the first time, run a wash cycle with detergent and no laundry, using the wash cycle  (60°C).

### Technical data

<b>Model</b>	WMD 942
<b>Dimensions</b>	width 59,5 cm height 85 cm depth 60,5 cm
<b>Capacity</b>	from 1 to 9 kg
<b>Electrical connections</b>	please refer to the technical data plate fixed to the machine
<b>Water connections</b>	maximum pressure 1 MPa (10 bar) minimum pressure 0.05 MPa (0.5 bar) drum capacity 62 litres
<b>Spin speed</b>	up to 1400 rotations per minute
<b>Test Programmes according to 2010/1061</b>	programme  ; temperature 60°C (2nd press of the button); temperature 40°C (3rd press of the button).
 	This appliance conforms to the following EC Directives: - 2004/108/EC (Electromagnetic Compatibility) - 2006/95/EC (Low Voltage) - 2002/96/EC

GB

# Description of the washing machine

## Control panel

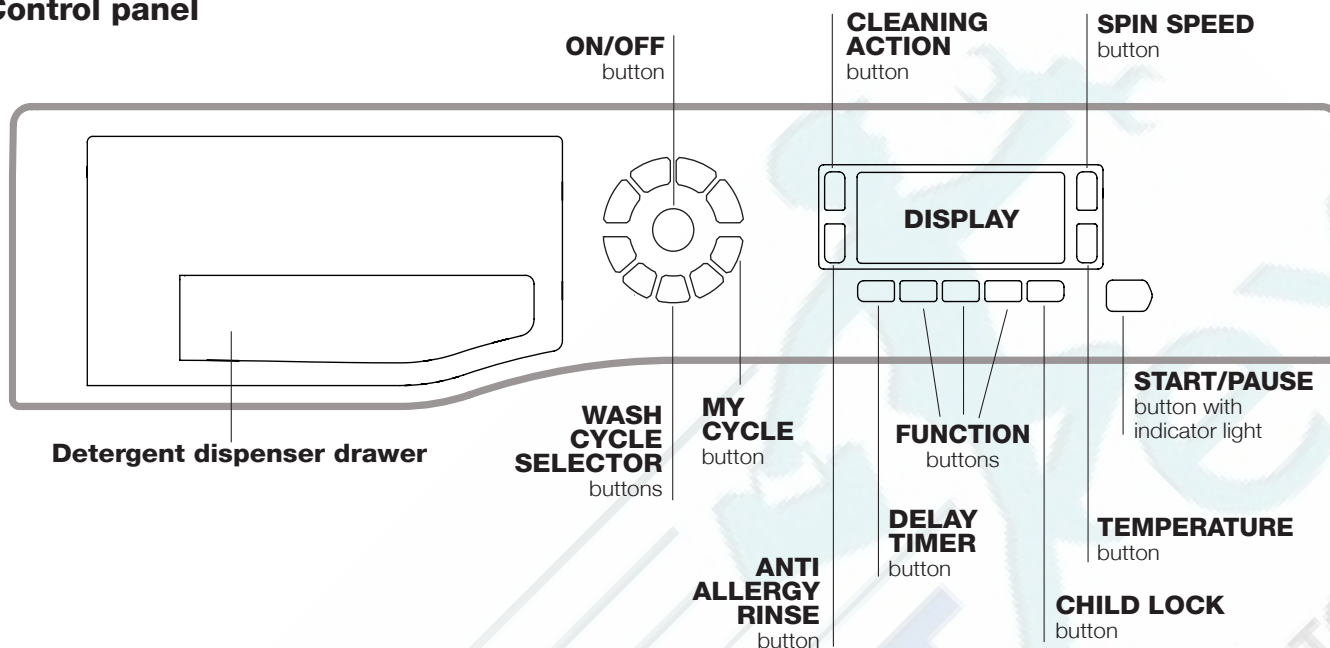

**Detergent dispenser drawer:** used to dispense detergents and washing additives (see “Detergents and laundry”).

**ON/OFF button** : press this briefly to switch the machine on or off. The START/PAUSE indicator light, which flashes slowly in a green colour shows that the machine is switched on. To switch off the washing machine during the wash cycle, press and hold the button for approximately 3 seconds; if the button is pressed briefly or accidentally the machine will not switch off. If the machine is switched off during a wash cycle, this wash cycle will be cancelled.

**WASH CYCLE SELECTOR** buttons: used to set the desired wash cycle (see “Table of wash cycles”).

**MY CYCLE** button: press and hold the button to store a cycle with your own set of preferences in the memory of the machine. To recall a previously stored cycle, press the MY CYCLE button.



**FUNCTION** buttons: press the button to select the desired function. The corresponding indicator light on the display will switch on.

**CLEANING ACTION** button : to select the desired wash intensity.

**ANTI ALLERGY RINSE** button : press to select the desired rinse type.

**SPIN** button : press to reduce or completely exclude the spin cycle - the value is indicated on the display.

**TEMPERATURE** button : press to decrease the temperature: the value will be shown on the display.

**CHILD LOCK** button : to activate the control panel lock, press and hold the button for approximately 2 seconds. When the symbol  is illuminated, the control panel is locked. This means it is possible to prevent wash cycles from being modified accidentally, especially where there are children in the home. To deactivate the control panel lock, press and hold the button for approximately 2 seconds.

**DELAY TIMER** button : press to set a delayed start time for the selected wash cycle. The delay time will be shown on the display.

**START/PAUSE** button with indicator light: when the green indicator light flashes slowly, press the button to start a wash cycle. Once the cycle has started the indicator light will remain lit in a fixed manner. To pause the wash cycle, press the button again; the indicator light will flash in an orange colour. If the symbol  is not illuminated, the door may be opened. To start the wash cycle from the point at which it was interrupted, press the button again.

### Standby mode

This washing machine, in compliance with new energy saving regulations, is fitted with an automatic standby system which is enabled after about 30 minutes if no activity is detected. Press the ON-OFF button briefly and wait for the machine to start up again.



## Display

GB

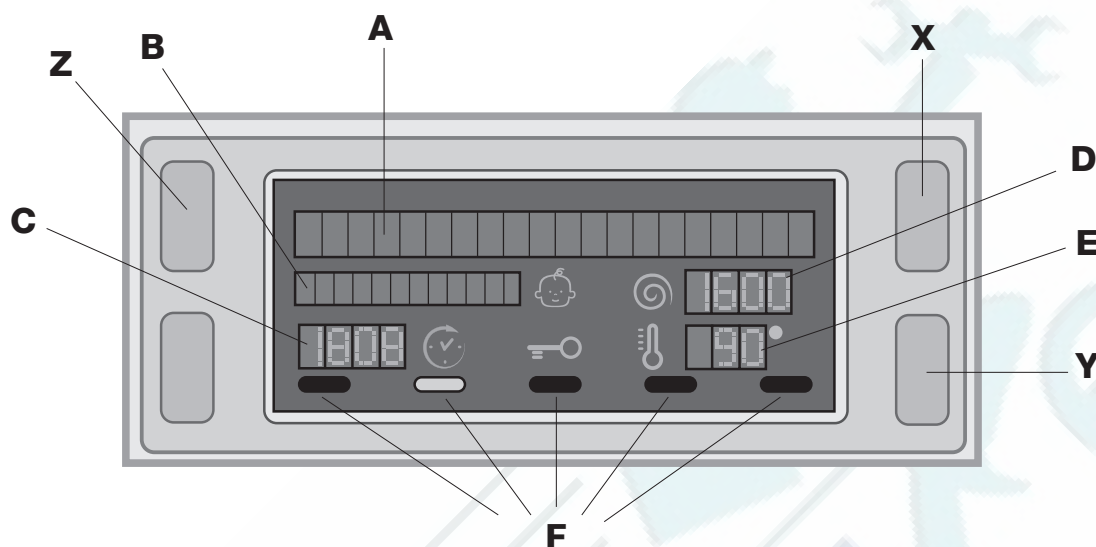

The display is useful when programming the machine and provides a great deal of information.

The two upper strings **A** and **B** provide details of the wash cycle selected, the wash cycle phase in progress and all information relating to the progress status of the wash cycle.

String **C** shows the time remaining until the end of the wash cycle in progress and, if a DELAYED START has been set, the time remaining until the start of the selected wash cycle.

String **D** shows the maximum spin speed value (this depends on the selected wash cycle); if the wash cycle does not include a spin cycle, the string remains unused.

String **E** shows the maximum temperature value which may be selected (this depends on the wash cycle used); if the temperature of the wash cycle cannot be modified, the string remains unused.

Indicator lights **F** correspond to the functions and light up when the selected function is compatible with the set wash cycle.

### Door locked symbol

If the symbol is lit, this indicates that the washing machine door is blocked to prevent it from being opened accidentally. To prevent any damage from occurring, wait for the symbol to switch itself off before opening the appliance door.

N.B.: if the DELAYE TIMER function has been activated, the door cannot be opened; pauses the machine by pressing the START/PAUSE button if you wish to open it.

**!** The first time the machine is switched on, you will be asked to select the language and the display will automatically show the language selection menu.



To select the desired language press the **X** and **Y** buttons; to confirm the selection press the **Z** button.

To change the language switch off the machine and press buttons **X**, **Y**, **Z** **simultaneously** until an alarm is heard: the language-selection menu will be displayed again.

# Running a wash cycle

GB



- 1. SWITCH THE MACHINE ON.** Press the On/Off button ; the text POWER ON will appear on the display and the START/PAUSE indicator light will flash slowly in a green colour.
- 2. LOAD THE LAUNDRY.** Open the porthole door. Load the laundry, making sure you do not exceed the maximum load value indicated in the table of programmes on the following page.
- 3. MEASURE OUT THE DETERGENT.** Open the detergent dispenser drawer and pour the detergent into the relevant compartments as described in "Detergents and laundry".
- 4. CLOSE THE DOOR.**
- 5. SELECT THE WASH CYCLE.** Press one of the WASH CYCLE SELECTOR buttons to select the required wash cycle; the name of the wash cycle will appear on the display. A temperature and spin speed is set for each wash cycle; these may be adjusted. The duration of the cycle will appear on the display.
- 6. CUSTOMISE THE WASH CYCLE.** Use the relevant buttons:

 **Modifying the temperature and/or spin speed.** The machine automatically selects the maximum temperature and spin speed set for the selected wash cycle; these values cannot therefore be increased. The temperature can be decreased by pressing the  button, until the cold wash "OFF" setting is reached. The spin speed may be progressively reduced by pressing the  button, until it is completely excluded (the "OFF" setting). If these buttons are pressed again, the maximum values are restored.

#### Setting a delayed start.

To set a delayed start for the selected programme, press the corresponding button repeatedly until the required delay period has been reached. When this option is enabled, the  symbol lights up on the display. To remove the delayed start function press the button until the text "OFF" appears on the display.

#### Set the desired wash intensity.

Option  makes it possible to optimise washing based on the level of soil in the fabrics and on desired wash cycle intensity. Select the wash programme: the cycle will be automatically set to "Normal" as optimised for garments with an average level of soil (this setting is not applicable to the "Wool" cycle, which is automatically set to "Delicate"). For heavily-soiled garments press button  until the "Super Wash" level is reached. This level ensures a high-performance wash due to a larger quantity of water used in the initial phase of the cycle and due to increased drum rotation. It is useful when removing the most stubborn stains.

It can be used **with** or **without** bleach. If you wish to bleach the items insert the additional compartment (4) into compartment 1. When pouring the bleach, be careful not to exceed the "max" level marked on the central pivot (see figure pag. 8).

For lightly-soiled garments or a more delicate treatment of the fabrics, press button  until the "Delicate" level is reached.

The cycle will reduce the drum rotation to ensure washing results are perfect for delicate garments. If the current selection can be neither set nor changed, the display will show "Not allowed".

#### Set the rinse type.

Option  makes it possible to select the desired rinse type for sensitive skin. Press the button once for the "Extra Rinse" level, which makes it possible to select an additional rinse after the standard cycle rinse and remove all traces of detergent. Press the button again for the "Sensitive Skin" level, which makes it possible to select two additional rinses to the standard cycle rinses; it is recommended for very sensitive skin. Press the button for the third time for the "Anti allergy Rinse" level, which makes it possible to select three additional rinses to the standard cycle rinses and remove major allergens such as pollen, mites, cat and dog hair. Press the button again to go back to the "Normal Rinse" rinse type. If the current adjustment can be neither set nor changed, the display will show "Not allowed".

#### **Modifying the cycle settings.**

- Press the button to enable the function; the indicator light corresponding to the button will switch on.
- Press the button again to disable the function; the indicator light will switch off.

! If the selected function is not compatible with the programmed wash cycle, the indicator light will flash and the function will not be activated.

! If the selected function is not compatible with another function which has been selected previously, the indicator light corresponding to the first function selected will flash and only the second function will be activated; the indicator light corresponding to the enabled function will remain lit.

! The functions may affect the recommended load value and/or the duration of the cycle.

- 7. START THE PROGRAMME.** Press the START/PAUSE button. The corresponding indicator light will become green, remaining lit in a fixed manner, and the door will be locked (the DOOR LOCKED symbol will be on). During the wash cycle, the name of the phase in progress will appear on the display. To change a wash cycle while it is in progress, pause the washing machine using the START/PAUSE button (the START/PAUSE indicator light will flash slowly in an orange colour); then select the desired cycle and press the START/PAUSE button again. To open the door while a cycle is in progress, press the START/PAUSE button; if the DOOR LOCKED  symbol is switched off the door may be opened. Press the START/PAUSE button again to restart the wash cycle from the point at which it was interrupted.

- 8. THE END OF THE WASH CYCLE.** This will be indicated by the text "END OF CYCLE" on the display; when the DOOR LOCKED  symbol switches off the door may be opened. Open the door, unload the laundry and switch off the machine.

! If you wish to cancel a cycle which has already begun, press and hold the  button. The cycle will be stopped and the machine will switch off.

# Wash cycles and functions

## Table of wash cycles

Wash cycles	Description of the wash cycle	Max. temp. (°C)	Max. speed (rpm)	Detergents				Max. load (kg)		Cycle duration
				Pre-Wash	Wash	Bleach	Fabric softener	Normal	Eco Wash	
	<b>Anti Stain</b>	40°	1400	-	●	-	●	5	-	The duration of the wash cycles can be checked on the display.
	<b>Cotton</b> Prewash (1st press of the button): extremely soiled whites and resistant colours.	90°	1400	●	●	-	●	9	-	
	White <b>Cottons (1)</b> (2nd press of the button): heavily soiled whites and delicate colours.	60°	1400	-	●	●	●	9	9	
	<b>Cottons</b> coloured (1-2) (3rd press of the button): lightly soiled whites and delicate colours.	40°	1400	-	●	●	●	9	9	
	<b>Synthetics</b> resistant (1st press of the button): heavily soiled resistant colours.	60°	800	-	●	●	●	4	3	
	<b>Synthetics</b> resistant (4) (1st press of the button): heavily soiled resistant colours.	40°	800	-	●	●	●	4	3	
	<b>Synthetics</b> delicate (2nd press of the button): lightly soiled resistant colours.	40°	800	-	●	●	●	4	3	
	<b>Fastwash 60'</b> (1st press of the button): to refresh normal soiled garments quickly (not suitable for wool, silk and clothes which require washing by hand).	60°	1400	-	●	-	●	3.5	3	
	<b>Fastwash 30'</b> (2nd press of the button): to refresh lightly soiled garments quickly (not suitable for wool, silk and clothes which require washing by hand).	30°	800	-	●	-	●	3.5	3	
<b>M</b>	<b>My Cycle (Memory):</b> allows for any wash cycle to be stored.									
	<b>7 Days (3):</b> washes bathroom laundry and bedlinen.	60°	1400	-	●	-	●	9	-	
	<b>Woolmark Platinum (Wool):</b> for wool, cashmere, etc.	40°	800	-	●	-	●	2	-	
	<b>Ultradelicates</b>	30°	0	-	●	-	●	1	-	
	<b>Fast spin</b> resistent (1st press of the button)	-	1400	-	-	-	-	9	-	
	<b>Rinse</b> cottons (2nd press of the button)	-	1400	-	-	-	●	9	-	
	<b>Pump out</b> (3rd press of the button)	-	0	-	-	-	-	9	-	

The length of cycle shown on the display or in this booklet is an estimation only and is calculated assuming standard working conditions. The actual duration can vary according to factors such as water temperature and pressure, the amount of detergent used, the amount and type of load inserted, load balancing and any wash options selected.

For all Test Institutes:

- 1) Test wash cycle in compliance with regulation 2010/1061: set wash cycle 60°C (2nd press of the button); set wash cycle 40°C (3rd press of the button).
- 2) Long wash cycle for cottons: set wash cycle 40°C (3rd press of the button).
- 3) Short wash cycle for cottons: set wash cycle ; temperature of 40°C (press TEMPERATURE button).
- 4) Long wash cycle for synthetics: set wash cycle 60°C (1st press of the button); temperature of 40°C (press TEMPERATURE button).

## Wash functions

### Timer Saver

If you select this option, the wash cycle duration will be reduced by up to 50%, depending on the selected cycle, thereby guaranteeing simultaneous water and energy saving. Use this cycle for lightly soiled garments.

! It cannot be used with the , "Fastwash 60'", , , .

### Easy Iron

By selecting this function, the wash and spin cycles will be modified in order to reduce the formation of creases.

At the end of the cycle the washing machine will perform slow rotations of the drum; the "Easy Iron" and START/PAUSE indicator lights will flash (orange) and the text "END OF CYCLE" will appear on the display. To end the cycle, press the START/PAUSE button or the "Easy Iron" button.

! It cannot be used with the , "Fastwash 30'", , , "Fast spin resistent" and "Pump out".

### Eco Wash

The Eco Wash function saves energy by not heating the water used to wash your laundry – an advantage both to the environment and to your energy bill. Instead, intensified wash action and water optimisation ensure great wash results in the same average time of a standard cycle. For the best washing results we recommend the usage of a liquid detergent.

! It cannot be used with the , , , , , .

GB



# Detergents and laundry

GB

## Detergent dispenser drawer

Good washing results also depend on the correct dose of detergent: adding too much detergent will not necessarily result in a more efficient wash, and may in fact cause a build up on the inside of your appliance and contribute to environmental pollution.

! Do not use hand washing detergents because these create too much foam.

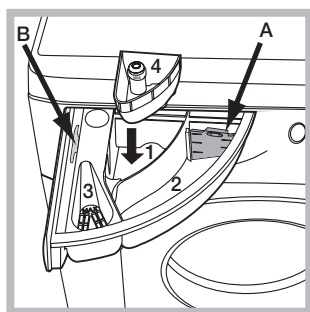

Open the detergent dispenser drawer and pour in the detergent or washing additive, as follows.

### compartment 1: Pre-wash detergent (powder)

Before pouring in the detergent, make sure that extra compartment 4 has been removed.

### compartment 2: Detergent for the wash cycle (powder or liquid)

If liquid detergent is used, it is recommended that the removable plastic partition A (supplied) be used for proper dosage.

If powder detergent is used, place the partition into slot B.

### compartment 3: Additives (fabric softeners, etc.)

The fabric softener should not overflow the grid.

### extra compartment 4: Bleach

## Preparing the laundry

- Divide the laundry according to:
  - the type of fabric/the symbol on the label
  - the colours: separate coloured garments from whites.
- Empty all garment pockets and check the buttons.
- Do not exceed the listed values, which refer to the weight of the laundry when dry:
  - Durable fabrics: max. 9 kg
  - Synthetic fabrics: max. 4 kg
  - Delicate fabrics: max. 2 kg
  - Wool: max. 2 kg
  - Silk: max. 2 kg



## How much does your laundry weigh?

- 1 sheet 400-500 g
- 1 pillow case 150-200 g
- 1 tablecloth 400-500 g
- 1 bathrobe 900-1200 g
- 1 towel 150-250 g



## Special wash cycles

**Anti Stain** : this programme is suitable to heavily-soiled garments with resistant colours. It ensures a washing class that is higher than the standard class (A class). When running the programme, do not mix garments of different colours. We recommend the use of powder detergent. Pre-treatment with special additives is recommended if there are obstinate stains.

**7 Days:** use programme  to wash bed linen and towels in one single cycle: it optimises softener performance and helps you save time and energy. We recommend the use of powder detergent.

**Wool:** is the only washing machine manufacturer to have been awarded the prestigious Woolmark Platinum Care endorsement (M.0508) by the Woolmark Company, which means that all woollen garments may be washed in the washing machine, even those which state "hand wash only"  on the label. Wash cycle  therefore offers complete peace of mind when washing woollen garments in the washing machine (max. load 2 kg) and guarantees optimal performance.

**Ultradelicates:** use programme  to wash very delicate garments having strasses or sequins.

To wash **silk** garments and **curtains** select the cycle  and set the "Delicate" level from option .

We recommend turning the garments inside out before washing and placing small items into the special bag for washing delicates. Use liquid detergent on delicate garments for best results.

## Load balancing system

Before every spin cycle, to avoid excessive vibrations and to distribute the load in a uniform manner, the drum rotates continuously at a speed which is slightly greater than the washing rotation speed. If, after several attempts, the load is not balanced correctly, the machine spins at a reduced spin speed. If the load is excessively unbalanced, the washing machine performs the distribution process instead of spinning. To encourage improved load distribution and balance, we recommend small and large garments are mixed in the load.



# Precautions and tips

! This washing machine was designed and constructed in accordance with international safety regulations. The following information is provided for safety reasons and must therefore be read carefully.

## General safety

- This appliance was designed for domestic use only.
- This appliance is not intended for use by persons (including children) with reduced physical, sensory or mental capabilities, or lack of experience and knowledge, unless they have been given supervision or instruction concerning use of the appliance by a person responsible for their safety. Children should be supervised to ensure that they do not play with the appliance.
- Do not touch the machine when barefoot or with wet or damp hands or feet.
- Do not pull on the power supply cable when unplugging the appliance from the electricity socket. Hold the plug and pull.
- Do not open the detergent dispenser drawer while the machine is in operation.
- Do not touch the drained water as it may reach extremely high temperatures.
- Never force the porthole door. This could damage the safety lock mechanism designed to prevent accidental opening.
- If the appliance breaks down, do not under any circumstances access the internal mechanisms in an attempt to repair it yourself.
- Always keep children well away from the appliance while it is operating.
- The door can become quite hot during the wash cycle.
- If the appliance has to be moved, work in a group of two or three people and handle it with the utmost care. Never try to do this alone, because the appliance is very heavy.
- Before loading laundry into the washing machine, make sure the drum is empty.

## Disposal

- Disposing of the packaging materials: observe local regulations so that the packaging may be re-used.
- The European Directive 2002/96/EC on Waste Electrical and Electronic Equipment, requires that old household electrical appliances must not be disposed of in the normal unsorted municipal waste stream. Old appliances must be collected separately in order to optimise the recovery and recycling of the materials they contain and reduce the impact on human health and the environment. The crossed out "wheeled bin" symbol on the product reminds you of your obligation, that when you dispose of the appliance it must be separately collected. Consumers should contact their local authority or retailer for information concerning the correct disposal of their old appliance.

## Opening the porthole door manually

In the event that it is not possible to open the porthole door due to a powercut, and if you wish to remove the laundry, proceed as follows:

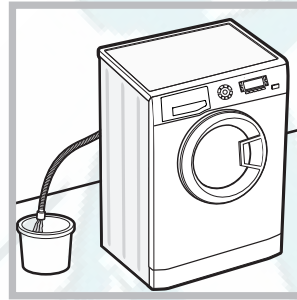

1. remove the plug from the electrical socket.
2. make sure the water level inside the machine is lower than the door opening; if it is not, remove excess water using the drain hose, collecting it in a bucket as indicated in the figure.

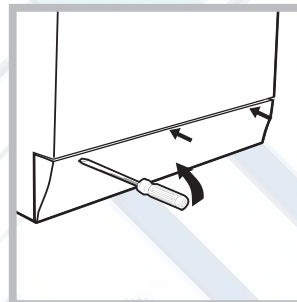

3. using a screwdriver, remove the cover panel on the lower front part of the washing machine (see figure).

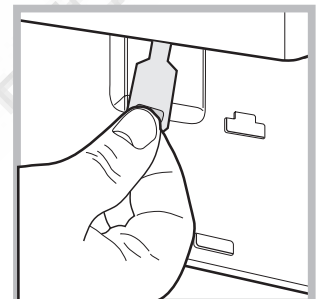
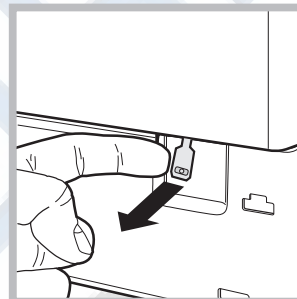

4. pull outwards using the tab as indicated in the figure, until the plastic tie-rod is freed from its stop position; pull downwards and open the door at the same time.

5. reposition the panel, making sure the hooks are securely in place before you push it onto the appliance.

GB

# Care and maintenance

GB

## Cutting off the water and electricity supplies

- Turn off the water tap after every wash cycle. This will limit wear on the hydraulic system inside the washing machine and help to prevent leaks.
- Unplug the washing machine when cleaning it and during all maintenance work.

## Cleaning the washing machine

- The outer parts and rubber components of the appliance can be cleaned using a soft cloth soaked in lukewarm soapy water. Do not use solvents or abrasives.
- The washing machine has a "Auto Clean" programme for its internal parts that **must be run with no load in the drum**.

For maximum performance you may want to use either the detergent (i.e. a quantity 10% the quantity specified for lightly-soiled garments) or special additives to clean the washing machine. We recommend running a cleaning programme every 40 wash cycles.

To start the programme press buttons **A** and **B** simultaneously for 5 seconds (see figure).

The programme will start automatically and will last approximately 70 minutes. To stop the cycle press the START/PAUSE button.

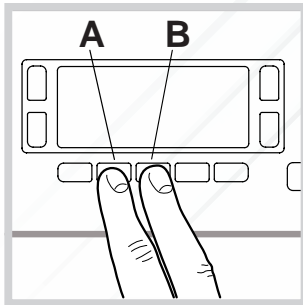

## Cleaning the detergent dispenser drawer

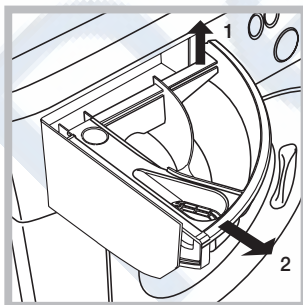

Remove the dispenser by raising it and pulling it out (see figure). Wash it under running water; this operation should be repeated frequently.

## Caring for the door and drum of your appliance

- Always leave the porthole door ajar in order to prevent unpleasant odours from forming.

## Cleaning the pump

The washing machine is fitted with a self-cleaning pump which does not require any maintenance. Sometimes, small items (such as coins or buttons) may fall into the pre-chamber which protects the pump, situated in its bottom part.

- ! Make sure the wash cycle has finished and unplug the appliance.

To access the pre-chamber:

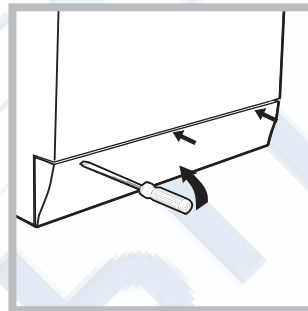

1. using a screwdriver, remove the cover panel on the lower front part of the washing machine (see figure);

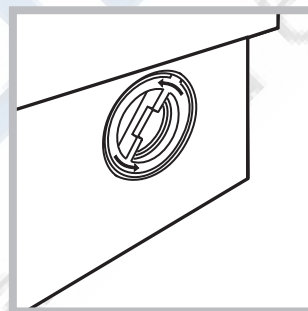

2. unscrew the lid by rotating it anti-clockwise (see figure): a little water may trickle out. This is perfectly normal;

3. clean the inside thoroughly;
4. screw the lid back on;
5. reposition the panel, making sure the hooks are securely in place before you push it onto the appliance.

## Checking the water inlet hose

Check the inlet hose at least once a year. If there are any cracks, it should be replaced immediately: during the wash cycles, water pressure is very strong and a cracked hose could easily split open.

- ! Never use second-hand hoses.

# Troubleshooting

GB

Your washing machine could fail to work. Before contacting the Technical Assistance Centre (see "Assistance"), make sure that the problem cannot be not solved easily using the following list.

## Problem:

**The washing machine does not switch on.**

## Possible causes / Solutions:

- The appliance is not plugged into the socket fully, or is not making contact.
- There is no power in the house.

**The wash cycle does not start.**

- The washing machine door is not closed properly.
- The ON/OFF button has not been pressed.
- The START/PAUSE button has not been pressed.
- The water tap has not been opened.
- A delayed start has been set (see "Running a wash cycle").

**The washing machine does not take in water (the text "NO WATER, CHECK SUPPLY" appears on the display).**

- The water inlet hose is not connected to the tap.
- The hose is bent.
- The water tap has not been opened.
- There is no water supply in the house.
- The pressure is too low.
- The START/PAUSE button has not been pressed.

**The washing machine continuously takes in and drains water.**

- The drain hose is not fitted at a height between 65 and 100 cm from the floor (see "Installation").
- The free end of the hose is under water (see "Installation").
- The wall drainage system is not fitted with a breather pipe.

If the problem persists even after these checks, turn off the water tap, switch the appliance off and contact the Assistance Service. If the dwelling is on one of the upper floors of a building, there may be problems relating to water drainage, causing the washing machine to fill with water and drain continuously. Special anti-draining valves are available in shops and help to avoid this inconvenience.

**The washing machine does not drain or spin.**

- The wash cycle does not include draining: some wash cycles require the drain phase to be started manually (see "Wash cycles and functions").
- The EASY IRON function has been activated: To complete the wash cycle, press the START/PAUSE button (see "Wash cycles and functions").
- The drain hose is bent (see "Installation").
- The drainage duct is clogged.

**The washing machine vibrates a lot during the spin cycle.**

- The drum was not unlocked correctly during installation (see "Installation").
- The washing machine is not level (see "Installation").
- The washing machine is trapped between cabinets and walls (see "Installation").

**The washing machine leaks.**

- The water inlet hose is not screwed on properly (see "Installation").
- The detergent dispenser drawer is blocked (for cleaning instructions, see "Care and maintenance").
- The drain hose is not fixed properly (see "Installation").

**The machine is locked and the display flashes, indicating an error code (e.g. F-01, F-..).**

- Switch off the machine and unplug it, wait for approximately 1 minute and then switch it back on again.  
If the problem persists, contact the Technical Assistance Service.

**There is too much foam.**

- The detergent is not suitable for machine washing (it should display the text "for washing machines" or "hand and machine wash", or the like).
- Too much detergent was used.



# Service

GB

**Before calling for Assistance:**

- Check whether you can solve the problem alone (see “*Troubleshooting*”);
- Restart the programme to check whether the problem has been solved;
- If this is not the case, contact an authorised Technical Assistance Centre using the telephone number provided on the guarantee certificate.

! Always request the assistance of authorised technicians.

**Have the following information to hand:**

- the type of problem;
- the appliance model (Mod.);
- the serial number (S/N).

This information can be found on the data plate applied to the rear of the washing machine, and can also be found on the front of the appliance by opening the door.